

# HEAT SINK HS053

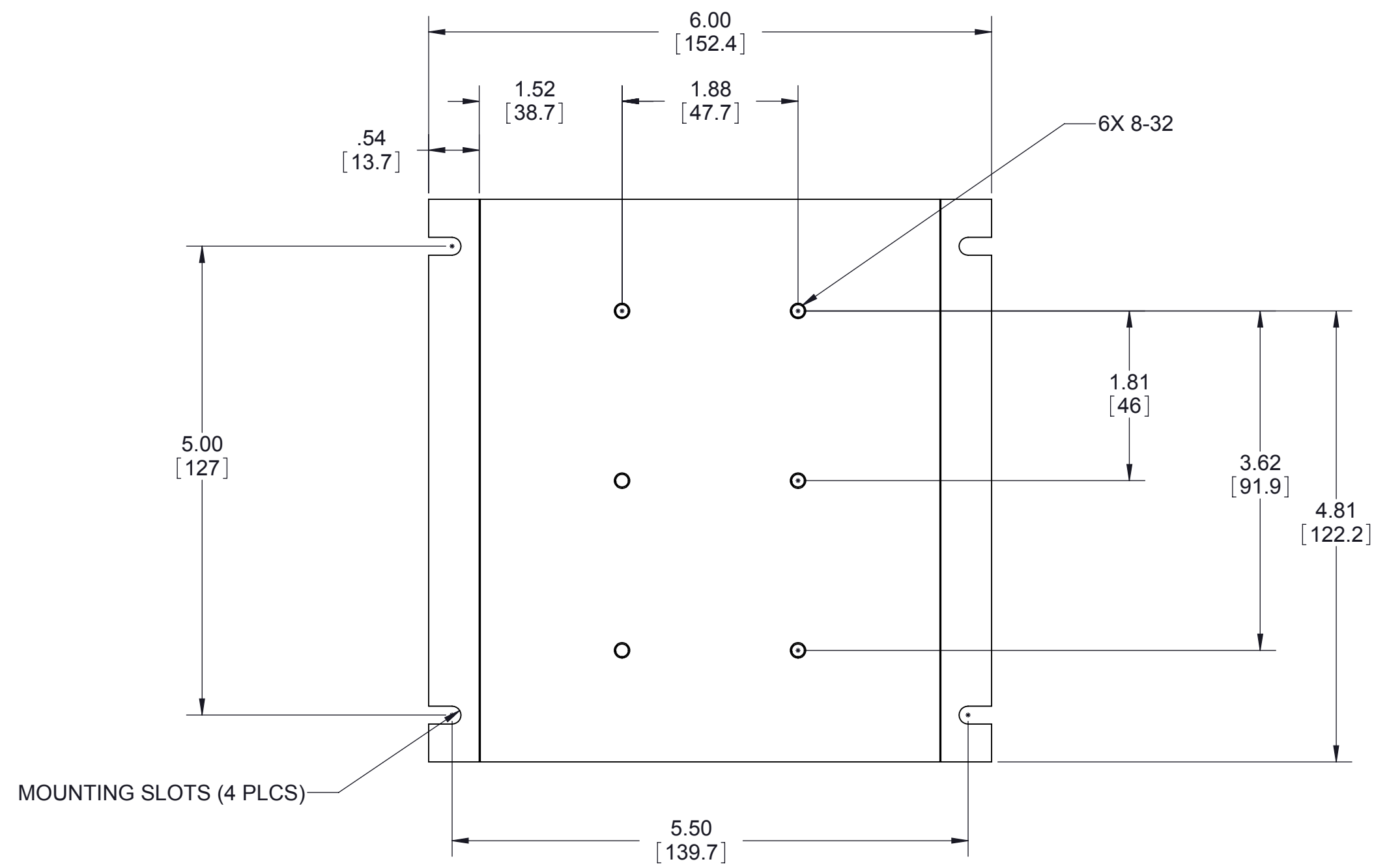
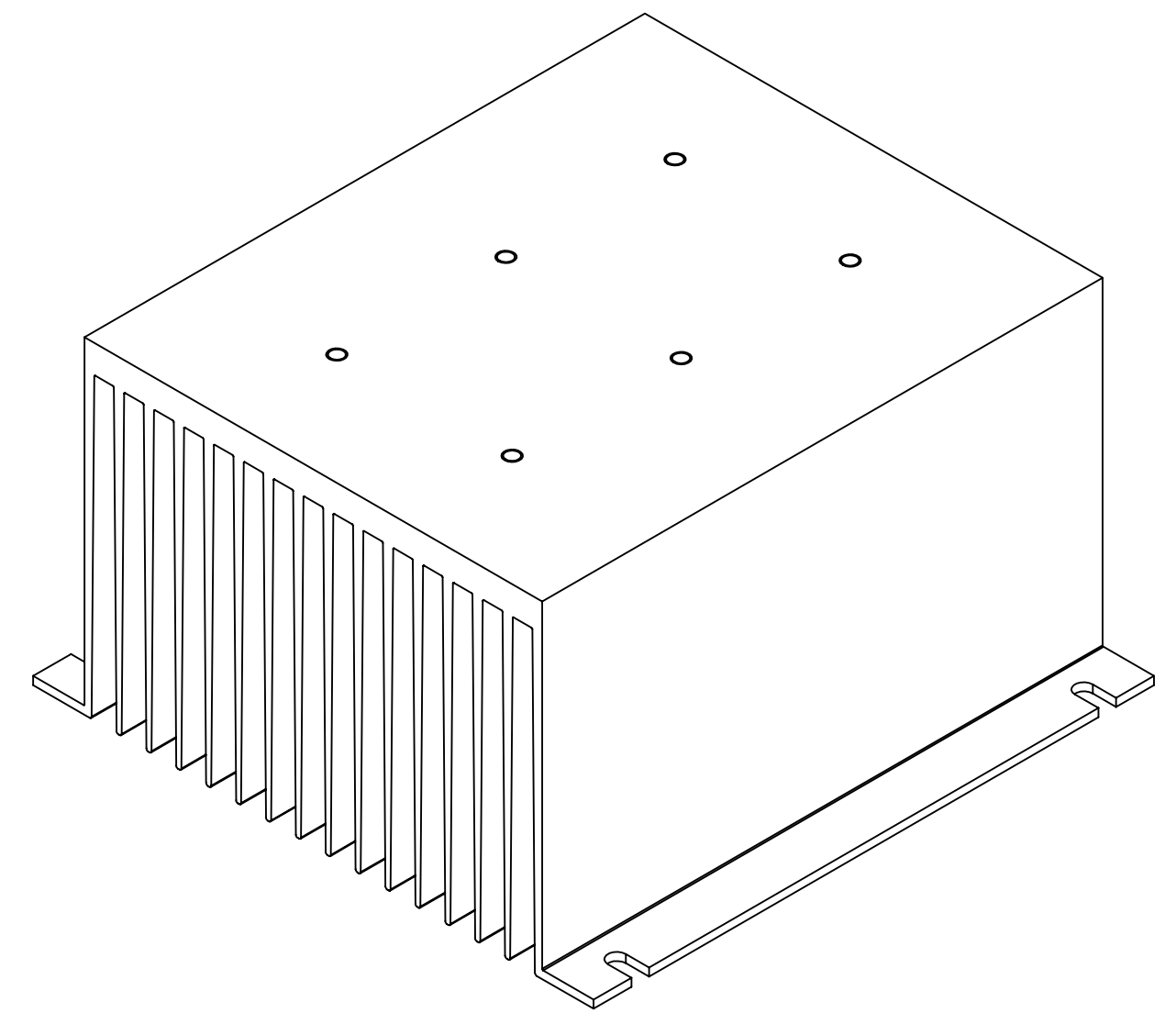
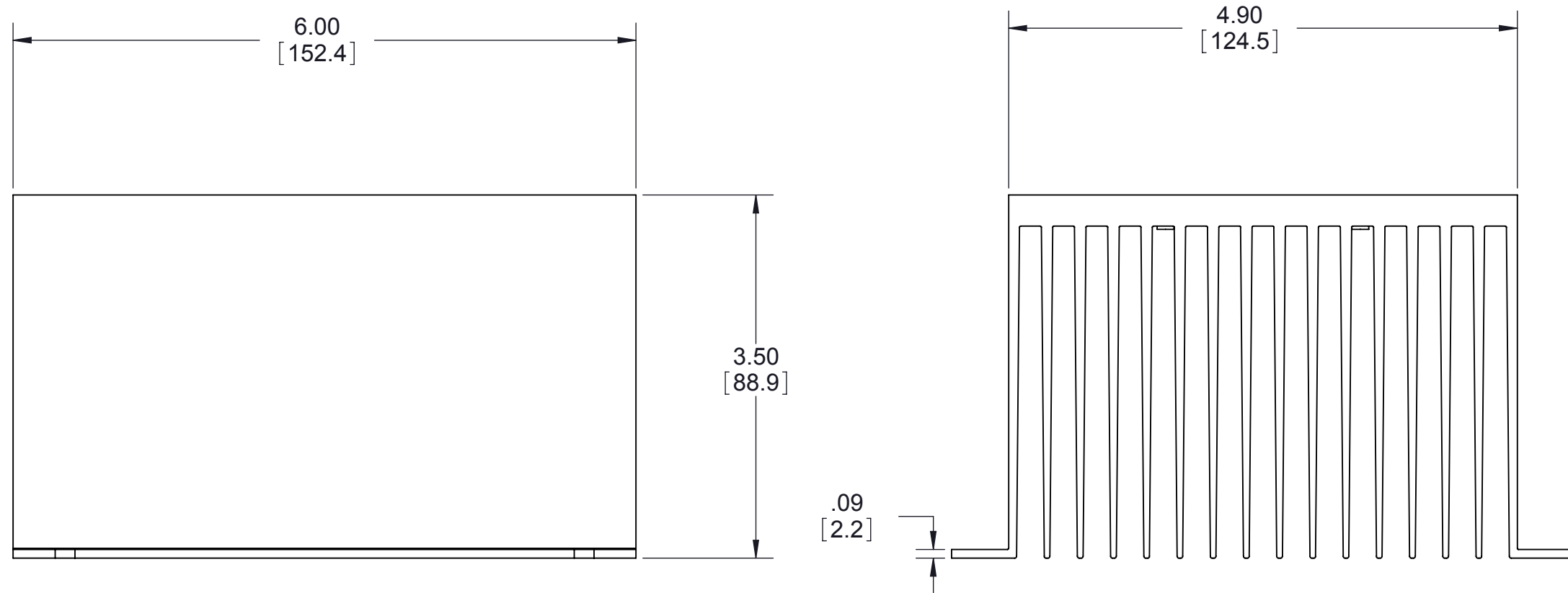

Tolerances:  $\pm 0.02$  in / 0.5 mm. All dimensions are in: inches [millimeters]